

LED Command Center D621

User's Guide

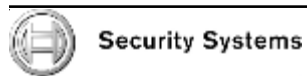

Security Systems

BOSCH

National Security Systems (800)457-1999

<http://nationalecuritysystems.com>

D621 User's Guide

MY SECURITY COMPANY IS:

CALL BEFORE TEST: _____

THIS SECURITY SYSTEM IS CONNECTED TO TELEPHONE NUMBER:

THE SECURITY CONTROL PANEL IS CONNECTED TO THE PHONE JACK LOCATED:

TRANSFORMER LOCATION: _____

CIRCUIT BREAKER NUMBER: _____

D621 User's Guide

Table of Contents

About This User's Guide	5
Introduction	5
Security System Basics	6
What is a Point?	6
What is a Faulted Point?	6
Are All Points the Same?	6
Controlled Points	6
24-Hour Points	6
All On	7
Part On	7
Command Center Keys	8
Command Center Tones	9
Command Center LED Descriptions	10
Commands	10
System Events	10
Fire Alarms	11
Burglary Alarms	11
Fire Trouble Events	11
Non-Fire Trouble Events	11
How Your System Reports Alarms	12
Silence Alarms	12
Keypad Adjust (Cmd 49)	12
Log Out of the System	13
Turn the System Off	13
Turn the System All On (All On or Cmd 1)	14
Turn the System Part On (Part On or Cmd 2)	15
Turn the System Part 2 On (Cmd 3)	16
Set Part 2 Points (Cmd 65)	17
Turn the System On with No Delay	18
Turn the System On with No Exit Tone	19
Turn the System On with Points Faulted (Force Arm)	20
Bypass Points	21
Date and Time (Cmd 45)	22
Change a Passcode (Cmd 55)	23
Change Others' Passcodes (Cmd 56)	24
Change Others' Passcode Level (Cmd 56)	25
Add a Passcode (Cmd 56)	26
Delete a Passcode (Cmd 58)	27
Renew One-Time Passcodes (Cmd 53)	28

D621 User's Guide

Check System Troubles (Cmd 4)	29
View Alarm Memory (Cmd 40)	30
View System Trouble (Cmd 42)	31
View Point Trouble (Cmd 48)	32
System Test (Cmd 41)	33
Walk Test (Cmd 44)	34
Reset the System (Cmd 47)	35
Turn Watch On/Off (Cmd 61)	36
Select Watch Tone (Cmd 62)	37
Select Watch Points (Cmd 63)	39
Extend Auto On Time (Cmd 51)	40
All Areas On (Cmd 80)	40
All Areas Off (Cmd 81)	41
Auto-Forward On/Off (Cmd 82)	41
Remote Arming with Telephone, Area 1	42
Remote Program (Cmd 43)	42
Security System Limitations	43
Fire Safety and Evacuation	44
Maintenance and Service	45
Power Failure	45
How to Clean the Command Center	45
Glossary	46
Index	48

Figures

Figure 1: Command Center	5
Figure 2: All On	7
Figure 3: Part On	7

Tables

Table 1: Command Center Keys	8
Table 2: Command Center Tones	9
Table 3: Command Center LED Descriptions	10
Table 4: Exit Tones	19
Table 5: System Troubles	29
Table 6: System Trouble Events	31
Table 7: Trouble Points	32
Table 8: System Test Lights	33
Table 9: System Test Point Status	34
Table 10: Watch Tones	37
Table 11: Watch Tone Description	38

About This User's Guide

This user's guide shows you how to use and maintain your security system. It covers basic functions, such as turning the system on and off.

The functions described in this guide are programmed by your security company. Some of them may not be enabled in your system. Certain functions covered may require you to enter your personal passcode.

Introduction

Your system helps to secure life, property, and investments against fire, theft and bodily harm. It consists of one or more Command Centers, motion sensors (such as detectors or devices located on doors and windows), and sensing devices designed to detect the presence of smoke or combustion. Each device is connected to a sophisticated control panel with microprocessor, which processes all events registered by the system.

Control of your security system is achieved through the Command Center, which offers a variety of basic and advanced features. Its function, versatility, and ease of operation make it ideal for home or office use. The Command Center, shown in *Figure 1*, is tailored to meet your individual needs. Moreover, it has been designed with you, the user, in mind.

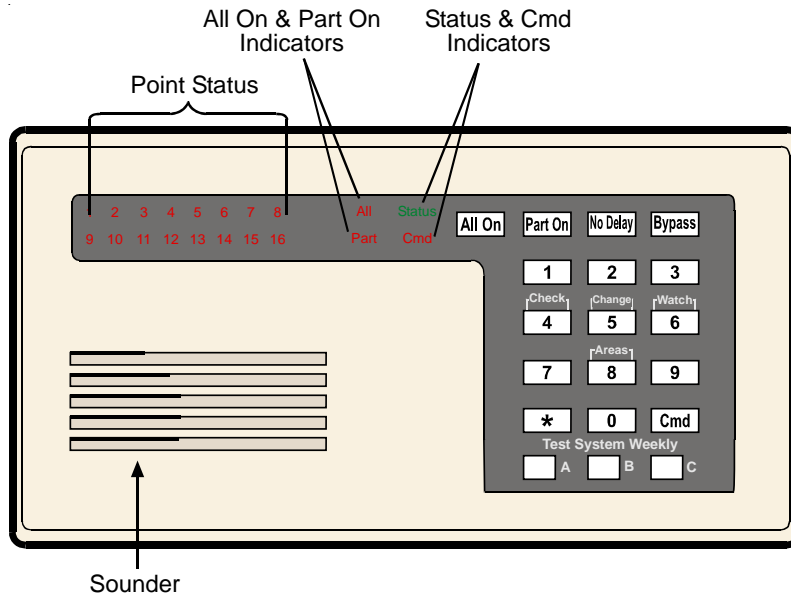

Figure 1: Command Center

D621 User's Guide

Security System Basics

What is a Point?

A **Point** is a detection device or group of devices connected to your security system. Points are identified by the area they monitor, such as a front door, bedroom window, or hallway.

What is a Faulted Point?

When a point (such as a door or window) is closed, it is said to be normal. When the door or window is open, the point is said to be **faulted** or not normal. When you turn your system on, you will usually want all of the points in your system to be normal. However, you can turn your system on with faulted points by using the Bypass Points command.

If a point indicator on the Command Center is on, the point is said to be faulted. When the faulted point has returned to normal, the point indicator on the Command Center turns off.

Are All Points the Same?

Not all points are the same. In fact, there are two basic types of points: Controlled and 24-Hour.

Controlled Points

Controlled Points respond to alarm conditions depending upon whether the system is turned on or off. They are programmed to either respond instantly to alarm conditions or to provide a delay for you to reach the Command Center and turn the system off. Various controlled points may be located throughout your house.

When you turn your system on, you have the option of turning on all controlled points (*All On*), or just some of the controlled points (*Part On*). See *All On* and *Part On* for more information.

24-Hour Points

24-Hour Points are always on, even when the system is turned off. There are two types of 24-Hour Points: Fire and Non-Fire. See *Reset the System* for more information.

- **Fire Points:** Only monitor fire detection devices, such as smoke detectors. They are always on and cannot be turned off.
- **Non-Fire Points:** Always on and cannot be turned off.

D621 User's Guide

All On

When you turn your system All On (see *Figure 2*), you are turning on all controlled points, both interior (motion detectors) and perimeter (doors and windows of the building).

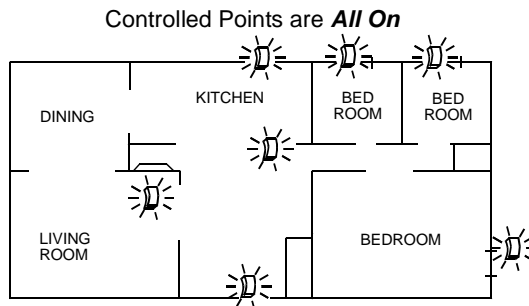

Figure 2: All On

Part On

When you turn your system Part On (see *Figure 3*), you are turning on only a portion of the controlled points. The particular points included in this portion are determined by your alarm company. Part points may include only the perimeter (doors and windows) of your system, or the points on the first floor of a two-story house. Check with your security company to learn which points are Part points.

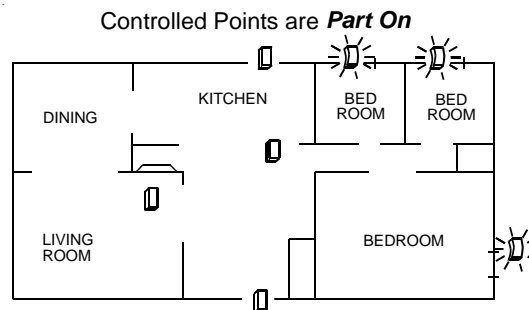

Figure 3: Part On

D621 User's Guide

Command Center Keys

Your LED Command Center has nineteen keys to perform the various functions described in *Table 1*.

Key	Function
[1], [2], [3], [4], [5], [6], [7], [8], [9], [0]	Numeric keys used for entering passcodes and issuing commands.
[CMD]	Used in conjunction with numeric keys to enter commands. Also displays system status.
[ALL ON]	Lets you turn your system All On. See <i>Turning the System All On</i> .
[PART ON]	Lets you turn your system Part On. See <i>Turning the System Part On</i> .
[NO DELAY]	Lets you turn your system All On or Part On without entry or exit delay. See <i>Turning the System On with No Delay</i> .
[BYPASS]	Lets you bypass one or more points. See <i>Bypass Points</i> .
[*]	When available, advances to the next display.
[A], [B], [C]	Emergency functions (Fire, Panic, or Emergency Alarms) may be assigned to these keys by your installing company. To activate the special function, press the key twice (consecutively) within 2 seconds. Your security company labels each key to its assigned function.

Table 1: Command Center Keys

Command Center Tones

The Command Center emits several distinct tones and illuminates lights to alert you to system events as described in *Table 2*.

Tone	Tone Pattern	Description
Fire Alarm	---	When fire point activates, the Command Center emits a repeated warble tone (on for 2 sec., then briefly off).
Burglary Alarm	—————	When a burglary point activates while your system is turned on, the Command Center emits a continuous warble tone. The sounder remains on for the duration of the time set by your security company.
Trouble		When a system component is not functioning properly, the Command Center emits a repeated warble tone. Press [4] to view the trouble. If problem is point-related, the Command Center display indicates the faulted point.
Key Press	–	Pressing any key on the Command Center sounds a short pip to indicate the pressed key is accepted.
Entry Delay	-----	When you enter the premises through a point programmed for Entry Delay, the Command Center emits an intermittent beep to remind you to turn your system off. If the system is not turned off before the entry delay expires, an alarm condition occurs and a report may be sent to your alarm company.
Exit Delay	--- --- ---	After you turn your system on, the Command Center emits an intermittent beep and counts down the Exit Delay time. If you do not exit before the exit delay time expires and an Exit Delay point is faulted, an alarm event begins.
Error	-----	If you press an incorrect key, the Command Center emits an error tone to indicate an invalid entry. The error tone is the same warble tone as the Trouble Tone, but is not repeated.
OK	———	Indicates a Command Center entry is accepted, such as a correctly entered passcode. The Command Center emits a single, high-pitched beep for 1 second.
Watch		Command Center emits a tone to alert you when any watched point is faulted. The tone varies in duration, depending on the selected Watched Tone. (See <i>Select Watch Tone</i> .)

Table 2: Command Center Tones

D621 User's Guide

Command Center LED Descriptions

Table 3 describes the Command Center LEDs.

LED	State	Description
Status	On	No system troubles.
	Slow Flash	AC failure, system trouble, or keypad was moved away from its assigned area.
	Fast Flash	Command Center in Command Mode System Test was initiated.
Cmd	Off	User logged off and no command is active.
	Fast Flash	Waiting for passcode entry.
	On	Exit Delay timer is active or a command is in progress.
All	Off	Panel disarmed or armed Part On.
	Slow Flash	Panel armed All On with No Delay.
	On	Panel armed All On with Entry/Exit Delay.
Part	Off	Panel disarmed or armed All On.
	Slow Flash	Panel armed Part On/Part 2 On with No Delay.
	On	Panel armed Part On/Part 2 On with Entry/Exit Delay.

Table 3: Command Center LED Descriptions

Commands

Commands allow you to carry out various tasks such as add or delete passcodes, set the date and time, or test the system. Each command is detailed throughout this user guide.

Commands are written as: [CMD] [6] [3]. To enter this command, first press the [CMD] key, followed by the [6] key, and then the [3] key.

System Events

Your system responds to four types of alarm events. If more than one event occurs, your system sorts them into one of four groups:

- Fire Alarms (highest priority)
- Burglary Alarms
- Fire Troubles
- Non-Fire Troubles (lowest priority)

Events grouped as highest priority are always sent to the central station first.

Fire Alarms

Fire alarms are the highest priority events. When a fire point activates, your Command Center emits a Fire Alarm tone (a repeated warble tone that is on for 2 sec., then briefly off). Evacuate all occupants and investigate for smoke or fire. Make sure all occupants know the difference between the Burglary Alarm tone and the Fire Alarm tone.

Burglary Alarms

Burglary alarms are the second priority. When a burglary point activates, your Command Center emits a Burglary Alarm tone. Ensure all occupants know the difference between the Burglary Alarm tone and the Fire Alarm tone.

The Command Center display shows each burglary point that went into alarm by flashing the point number (up to Point 16).

Fire Trouble Events

When a fire trouble (such as a loose wire) occurs, your Command Center emits a Trouble tone.

The Command Center Status indicator is on steady. See *Check System Troubles* for more information on determining the nature of the trouble.

Non-Fire Trouble Events

When a trouble event such as a low battery condition occurs, your Command Center emits a Trouble tone.

The Command Center Status indicator is on steady. See *Check System Troubles* for more information on determining the nature of the trouble.

D621 User's Guide

How Your System Reports Alarms

Your security system may be programmed to automatically disconnect your telephone when sending reports to your security company. Once the report is complete, the system returns the telephone to normal operation (verify with your installing company).

Your system makes repeated attempts to send reports to your security company. If your system fails to report, the Command Center signals a system trouble. See *Check System Troubles* for more information on determining the nature of the trouble.



If your telephone service is interrupted, your security system cannot send reports to your security company unless it has an alternate means of transmitting them.

Silence Alarms

When there is an alarm, the alarm tone sounds and the point(s) in alarm illuminate on the display (up to Point 16). If you enter your passcode before the system dials your security company, the alarm report is aborted.

1. Enter your passcode to silence the alarm and turn the system off (if it was turned on). An alarm report is sent if not acknowledged in time.
2. Press and hold the [CMD] key to remove the alarms (flashing point numbers) from the Command Center display. See *View Alarm Memory*, to see which points caused the alarm.

1	2	3	4	5	6	7	8	All	Status
9	10	11	12	13	14	15	16	Part	Cmd

Keypad Adjust (Cmd 49)

- I can perform this command.
- I cannot perform this command.

Use this command to adjust the Command Center sounder volume.

1. Press [CMD] [4] [9]. Enter your passcode if necessary.
2. To adjust the Command Center sounder volume, press and hold the [*] key and then press [1] to increase the volume or [4] to decrease the volume.
3. Press [CMD] to exit this command function when all adjustments are made.

Log Out of the System

The system remembers passcodes entered for approximately 10 sec. after you have stopped pressing keys. To log out of the system, press the [CMD] key twice. The Cmd LED remains off, acknowledging that you have successfully logged out.

Turn the System Off

Entry Delay Time (to be filled in by your security company).

You have _____ sec. to enter premises and turn system off.

Turn off the security system by entering your passcode. When the system is on, you must enter through a designated entry door to prevent an alarm. Opening a designated door starts the entry delay. During entry delay time, the Command Center emits a double tone every second to remind you to turn the system off. Enter your passcode before the entry delay time expires to turn the system off.

If you enter through the wrong door or fail to turn the system off before the entry delay time expires, you may cause an alarm. If an alarm occurs, silence the alarm by entering your passcode and call your security company to let them know it is not an emergency situation.

1. When the system is All On, the Command Center illuminates the All On indicator. If the system is Part On/Part 2 On, the Command Center illuminates the Part On indicator.

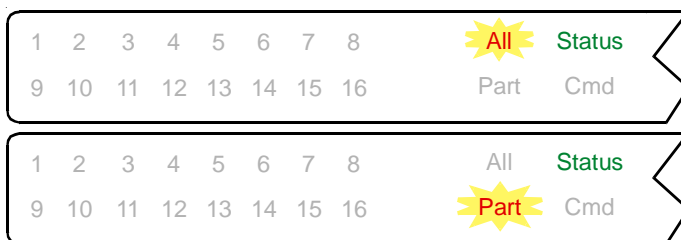

2. Enter your passcode to turn the system off. Once the system is off, the Command Center turns the All On indicator or the Part On indicator off.

D621 User's Guide

Turn the System All On (All On or Cmd 1)

- I can perform this command.
- I cannot perform this command.

Exit Delay Time (to be filled in by your security company).

You have _____ sec. to exit premises before system turns on.

Use this command to turn on the entire system. Once you press the All On key, the Exit Delay timer starts its countdown. Your security company programs the length of exit delay to ensure you have adequate time to exit.

You should leave the premises before the exit time expires. Leaving after exit delay expires starts an alarm event.

1. Make sure all points are normal (not faulted). If your system has a faulted point, return it to normal or bypass the point (see *Bypass Points*).
2. Press [ALL ON]. The Command Center may prompt you to enter a valid passcode if necessary by flashing the Cmd indicator.
3. Enter your passcode if necessary. Exit delay begins. The All On, Status, and Cmd indicators light. **You should leave at this time.**



During the exit delay, you may stop the system from turning on by entering your passcode.

If you wish, you can turn the system All On with No Delay by pressing [NO DELAY] or you may bypass points by pressing [BYPASS]. See *Bypass Points* for more information.

4. During the last 10 sec. of Exit Delay, the Command Center emits a double tone every second to warn you **not** to exit and to turn the system off. The system then turns All On. The All On indicator remains on steady.
5. To turn the system off, enter your passcode.

Turn the System Part On (Part On or Cmd 2)

- I can perform this command.
- I cannot perform this command.

Exit Delay Time (to be filled in by your security company).

You have _____ sec. to exit premises before system turns on.

Part On turns on part of your system, leaving the rest of the system turned off. Refer to the Point Identification section of your Command Center Reference Card to identify Part points designated for Part On activation.

Once you press the Part On key, the exit delay timer begins. You should leave the premises before the exit time expires. Leaving after exit delay expires starts an alarm event.

1. Make sure Part points are normal (not faulted).
2. Press [PART ON]. The Command Center may prompt you to enter a valid passcode by flashing the Cmd indicator.
3. Enter your passcode, if necessary. The Part On, Status, and Cmd indicators light. If your system has a faulted point (door or window open), you can either close it or bypass it (see *Bypass Points*).

During the exit delay, you may stop the system from turning on by entering your passcode.

4. During the last 10 sec. of Exit Delay, the Command Center emits a double tone every second to warn you **not** to exit and to turn the system off. The system then turns All On. The All On indicator remains on steady.



5. To turn the system off, enter your passcode.

D621 User's Guide

Turn the System Part 2 On (Cmd 3)

- I can perform this command.
- I cannot perform this command.

Exit Delay Time (to be filled in by your security company).

You have _____ sec. to exit premises before system turns on.

Part 2 On turns on part of your system designated as Part 2, leaving the rest of the system turned off. You can select the points that turn on for Part 2 On (see *Set Part 2 Points*).

1. Make sure Part 2 points are normal (not faulted). If your system has a faulted point, you should return it to normal, or bypass the point (see *Bypass Points*).
2. Press [CMD] [3] to turn the system Part 2 On. The Command Center may prompt you to enter a valid passcode by flashing the Cmd indicator.
3. Enter your passcode, if necessary. The Part On, Status, and Cmd indicators light and the exit delay time starts.

During exit delay, you may stop the system from turning on by entering your passcode.

If you wish, you can turn the system Part 2 On with No Delay by pressing [NO DELAY], or you may bypass points by pressing [BYPASS].

4. During the last 10 sec. of Exit Delay, the Command Center emits a double tone every second to warn you **not** to exit and to turn the system off. The system then turns All On. The All On indicator remains on steady.

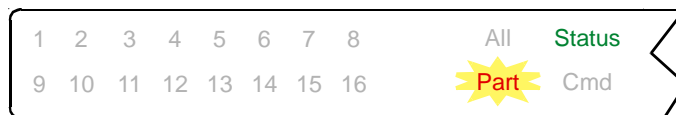

5. To turn the system off, enter your passcode.

Set Part 2 Points (Cmd 65)

- I can perform this command.
- I cannot perform this command.

Use this command to select which points are armed when you turn the system Part 2 On. This allows you to turn part of the system on to detect intrusion, while the remaining part of the system allows you to move freely without sounding an alarm.

1. Make sure the system is turned off (All and Part indicators are off).
2. Press [CMD] [6] [5]. The Command Center may prompt you to enter a valid passcode by flashing the Cmd indicator.
3. Enter your passcode if necessary. The Command Center indicates which points are available for selections. Points that are on steady are selected for Part 2, flashing points are available for selection.
4. Enter the Point Number you want to activate or deactivate for Part 2 On followed by the [*] key. Repeat this step until all points have been designated Yes or No for Part 2 Mode (Yes = Active, ready to detect intrusion; No = Non-Active, you can move freely without sounding an alarm).

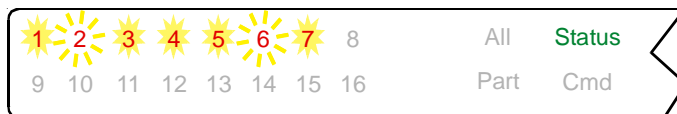

5. Press [CMD] to exit this command.

D621 User's Guide

Turn the System On with No Delay

Use this command to turn the system All On or Part On without entry or exit delays. Remember that turning the system on with no delay allows no exit or entry delay time through the designated delay point (for example, Front Door).

1. Make sure all points are normal (not faulted).
2. Press [ALL ON] if you want to turn the system All On or press [PART ON] if you want to turn the system Part On. Press [CMD] [3] if you want to turn the system Part 2 On. The Command Center may prompt you to enter a valid passcode by flashing the Cmd indicator.
3. Enter your passcode if necessary. The Command Center display lights the Cmd indicator and either the All On or Part On indicator.
4. Press [NO DELAY] to turn the system on with no delay. There is a 10-sec. window before the panel arms as No Delay.
5. To turn the system off, enter your passcode.

Turn the System On with No Exit Tone

Use this command to turn the entire system All On, Part On, or Part 2 On without any exit tones. Remember that turning the system on with no exit tone eliminates the tone emitted by the Command Center intended to alert occupants that the system is about to arm.

This command is useful when you want to arm the system, but not disturb the occupants while the system counts down prior to arming.

1. Make sure all points are normal (not faulted).
2. Press and hold the appropriate key to silence the exit tone (see *Table 4*). The Command Center may prompt you to enter a valid passcode.

Arming With	To Silence Exit Tone
All On	Press and hold [ALL ON]. OR Press [CMD], then press and hold [1].
Part On	Press and hold [PART ON]. OR Press [CMD], then press and hold [2].
Part 2 On	Press [CMD], then press and hold [3].

Table 4: Exit Tones



Silencing the Exit Delay Tone doubles the Exit Delay period.

- **All On (Cmd 1) Operation:** “All” and “Cmd” LEDs are on during the Exit Delay period.
- **Part On (Cmd 2) Operation:** “Part” and “Cmd” LEDs are on during the Exit Delay period.
- **Part 2 On (Cmd 3) Operation:** “Part” and “Cmd” LEDs are on during the Exit Delay period.

The Cmd indicator turns off when Exit Delay expires.

D621 User's Guide

Turn the System On with Points Faulted (Force Arm)



Force-arming is not permitted in UL applications.

- I can perform this command.
 - I cannot perform this command.
1. To force arm the system All On or Part On with the normal Exit Delay time and tone, press [ALL ON] or [PART ON]. The faulted point's LED indicator remains on. The Cmd indicator turns on. Press [ALL ON] or [PART ON] again. If the Cmd indicator flashes fast, enter your passcode. The All or Part indicator turns on, indicating the system is turning All On or Part On. The Exit Delay Time countdown begins with the exit tone. The faulted point's LED indicator flashes indicating that this point is force-armed.
 2. To force arm the system All On or Part On with doubled Exit Delay time and no exit tone, press and hold [ALL ON] or [PART ON] until the Cmd LED lights (after approximately 1 sec.). The faulted point's LED indicator remains on. Press [ALL ON] or [PART ON] again. If the Cmd indicator flashes, enter your passcode. The All or Part indicator turns on, indicating the system is turning All On or Part On. The Exit Delay Time countdown is doubled and begins without the exit tone. The faulted point's LED indicator flashes indicating that this point is force-armed. Once the panel is armed, the Cmd indicator turns off.

The system "forces" the faulted points on. As long as they remain faulted they do not provide protection. If they return to normal before the system is turned off they provide protection and are capable of starting alarm events. If a point becomes faulted after the exit delay begins, the Command Center displays the faulted point. If the point remains faulted at the end of exit delay, it starts an alarm event.

Bypass Points

- I can perform this command.
- I cannot perform this command.

Use this command to bypass one or more points before turning the system All On, Part On, or Part 2 On. When a point is bypassed, it can be faulted without starting an alarm event.

For example, your kitchen has just been painted and you want to leave the windows open but still turn on the system. Bypassing points allows the system to be on but prevents it from monitoring undesired areas.

1. Ensure the system is turned off (All and Part are not illuminated).
2. Press [BYPASS]. The Command Center may prompt you to enter a valid passcode by flashing the Cmd indicator.
3. Enter your passcode if necessary.
4. Enter the Point Number that you want to bypass followed by the [*] key. For example, if you want to bypass Point 10, enter [1] [0] [*]. Repeat this step until all points that are required to be bypassed are programmed.

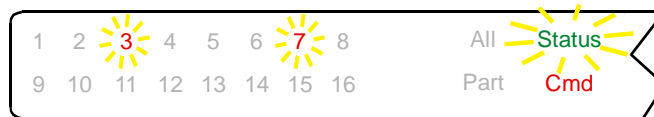

Bypassed points flash on the Command Center.

To un-bypass a point, repeat the steps above for the desired point number.

5. Press [CMD] to exit this command.

D621 User's Guide

Date and Time (Cmd 45)

- I can perform this command.
- I cannot perform this command.

Use this command to program the system's date and time.

1. Ensure the system is turned off (All and Part are not illuminated).
2. Press [CMD] [4] [5]. The Command Center may prompt you to enter a valid passcode by flashing the Cmd indicator.
3. Enter your passcode. The Command Center lights Point 1 on the display.
4. Enter the date and time using the MM/DD/YY, HH:MM format shown below.

_	_	/	_	_	/	_	_	:	_	_		
M	M		D	D		Y	Y		H	H	M	M
Month of			Day of			Current			Hour of		Minute of	
the year			the month			Year			the day		the hour	

The Command Center lights points 1 through 6 (each point represents a digit to be entered) for the date and points 1 through 4 for the time.



Note: *The time should be entered in 24-hr. format (8:00 p.m. = 20:00).*

5. After you enter the date and time, the Command Center sounds a long beep and automatically exits the Date and Time command.



In the event of a power cycle (power is lost to the system and then restored), the panel takes the last event in the log and uses that as a starting point for the time and date. Then, it alerts you to enter the current time and date.

Change a Passcode (Cmd 55)

- I can perform this command.
- I cannot perform this command.

Use this command to change your passcode at any time. **Only use this feature under the direction of your security company.** Write down your old passcode and the new one before you begin.

1. Make sure your system is off (All and Part indicators are off).
2. Press [CMD] [5] [5]. The Command Center flashes the Cmd indicator to prompt you to enter your passcode.
3. Enter your current passcode. The Command Center lights your user number (1 to 16).
4. Enter a new passcode with the same number of digits as your old passcode. If the error tone sounds, try a different new passcode.
5. Enter your new passcode again.
6. The Command Center sounds the OK tone and returns to the off state. You successfully changed your passcode.

D621 User's Guide

Change Others' Passcodes (Cmd 56)

- I can perform this command.
- I cannot perform this command.

Use this command to change passcodes for each user in the system. This command requires the appropriate authority level to change passcodes. **Only use this feature under the direction of your security company.**



IMPORTANT

Cmd 56 is only for changing passcodes other than the one used to access Cmd 56. For example, if User 1 performs Cmd 56, User 1 cannot modify User 1's own passcode. Use Cmd 55 instead.

1. Make sure the system is turned off (All and Part indicators are off).
2. Press [CMD] [5] [6]. The Command Center may prompt you to enter a valid passcode by flashing the Cmd indicator.
3. Enter your passcode. Point indicators 1, 2, and 3 flash.

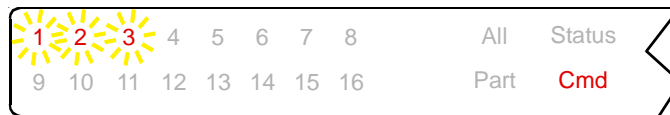

4. Press [1] to change passcodes. The available user numbers now flash.
5. Enter the user number you want to change followed by the [*] key. (For example, press [2] [*] to change the Passcode for User 2.) The point indicator for that particular user number now stays on steady.



IMPORTANT

If the user does not exist in the system, the Command Center emits an error tone.

6. Enter a new passcode with the same number of digits as the old passcode. If the error tone sounds, try a different new passcode. Enter the new passcode again for verification.
7. Press [CMD]. The available user numbers flash. Repeat Steps 5 and 6 to change another user passcode, or press [CMD] twice to exit.

Change Others' Passcode Level (Cmd 56)

- I can perform this command.
- I cannot perform this command.

Use this command to change passcode authority levels for each user in the system. This command requires the appropriate authority level to change passcodes. You cannot change your own passcode authority level. **Only use this feature under the direction of your security company.**

The following should be filled in by your security company.

- Authority Level 1 includes these commands:

- Authority Level 2 includes these commands:

- Authority Level 3 includes these commands:

- Authority Level 4 includes these commands:

1. Make sure the system is turned off (All and Part indicators are off).
2. Press [CMD] [5] [6]. The Command Center may prompt you to enter a valid passcode by flashing the Cmd indicator.
3. Enter your passcode. Point indicators 1, 2, and 3 flash.



4. Press [2] to change passcode authority levels. The available user numbers now flash.
5. Enter the user number that you want to change the authority level for, followed by the [*] key. (For example, press [3] [*] to change the authority level for User 3). The user number now turns on solid.



If the user does not exist in the system, the Command Center will emit an error tone.

6. Enter the new authority level (1 to 4) followed by [CMD].
7. The available user numbers flash. Select another user, or press [CMD] twice to exit.

D621 User's Guide

Add a Passcode (Cmd 56)

- I can perform this command.
- I cannot perform this command.

Use this command to add new passcodes to the system. This command requires the appropriate authority level to add passcodes. To add a new passcode to the system, you must assign an area(s) to the new user in addition to using the other Cmd 56 features (changing a passcode and changing a passcode authority level) as outlined below. **Only use this feature under the direction of your security company.**

1. Make sure the system is turned off (All and Part indicators are off).
2. Press [CMD] [5] [6]. The Command Center may prompt you to enter a valid passcode by flashing the Cmd indicator.
3. Enter your passcode. Point indicators 1, 2, and 3 flash.
4. Press [3] to assign an area(s) to the new user. The point indicators flash to indicate available users.
5. Enter the user number you want to add followed by the [*] key. (For example, to add User 4, press [4] [*].)
6. Enter the area(s) you want to assign to the new user by pressing the appropriate numeric key(s). For example, if the new user is to be assigned to Areas 1 and 2, press the [1] and [2] keys. To remove a currently assigned area(s), press the corresponding numeric key(s). The appropriate point indicator turns off. (For example, if User 4 is assigned to Areas 1 and 2, but should only be assigned to Area 1, press [2] to remove Area 2 from User 4's area assignment.)
7. Press [CMD] twice. Point indicators 1 to 3 flash.
8. Press [1] to assign a new passcode.
9. Enter the user number followed by the [*] key. (For example, press [4] [*] to create the passcode for User 4.)
10. Enter a new passcode. If the error tone sounds, try a different new passcode.
11. Enter the new passcode again for verification. Press [CMD] twice. Point indicators 1 to 3 flash.
12. Press [2] to assign a passcode authority level to the new user.

13. Enter the user number followed by the [*] key. (For example, press [4] [*] to assign an authority level for User 4.)
14. Enter the authority level.
15. Press the [CMD] key until the Command Center emits a single beep tone, the Cmd indicator turns off and the Status indicator turns on. This indicates that the Command Center has exited this command.



The new user passcode, area assignment, and authority level are automatically logged into the system's programming memory. Make sure your security company's programming records are properly updated.

Delete a Passcode (Cmd 58)

- I can perform this command.
- I cannot perform this command.

Use this command to delete passcodes. This command requires the appropriate authority level to delete passcodes.



You cannot delete your own passcode using this command. Only use this feature under the direction of your security company.

1. Make sure the system is turned off (All and Part indicators are off).
2. Press [CMD] [5] [8]. The Command Center may prompt you to enter a valid passcode by flashing the Cmd indicator.
3. Enter your passcode. The available user numbers flash.



4. Enter the user number you want to delete. (For example, press [2] [*] to delete User 2). You cannot delete yourself as a user.



If the user does not exist in the system as set up by your security company, the Command Center emits an error tone.

5. Press [CMD] to exit this command.

D621 User's Guide

Renew One-Time Passcodes (Cmd 53)

- I can perform this command.
- I cannot perform this command.

One-time passcodes can only be used once to turn the system off. This command allows those with the applicable authority level to renew previous One-Time passcodes. Once renewed, the One-Time passcode is again able to turn the system off only once.

1. Make sure the system is turned off (All and Part are off).
2. Press [CMD] [5] [3]. The Command Center may prompt you to enter a valid passcode by flashing the Cmd indicator.
3. Enter your passcode. The Command Center sounds the OK tone.
4. Press [0] [*] if you want to renew all one-time passcodes, or press the number of the user whose one-time code you want to renew followed by the [*] key. (For example, press [5] [*] to renew passcode 5.)
5. Press [CMD] to exit this command.

Check System Troubles (Cmd 4)

Your system emits a trouble tone to alert you to a system trouble event. System troubles are caused by things such as low batteries. Use this command to learn what is causing the trouble and what steps to take to correct it.

1. The system may be on or off when a system trouble occurs. If the system is on, you must turn it off to check the trouble.
2. Press [CMD] [4] to silence the trouble tone. The Command Center displays all system troubles. Follow the Command Center point indicators to determine the type of system trouble. See *Table 5*.

Point #	Description
1	Weekly Test Due Prompts you to conduct your weekly system test. See <i>System Test</i> .
2	System Trouble Press [2] to determine the specific trouble. See <i>View System Trouble</i> .
3	Remote Program Session Active Security company is currently connected to your system via the telephone line.
5	Date and Time Lost Press [5] to set the date and time.
6	Running on Battery Only Power to your system is disconnected or has failed.
8	Point Trouble Press [8] to determine which point trouble is current. See <i>View Point Trouble</i> .
10	Alarm Memory Press [0] to view previous alarms that occurred.

Table 5: System Troubles

3. Press [CMD] to exit this command.



The trouble tone for AC Failure events sounds at all command centers in all areas. However, the trouble tone must be silenced in each area (silencing it in one area does not silence it in the other areas).

D621 User's Guide

View Alarm Memory (Cmd 40)

- I can perform this command.
- I cannot perform this command.

After an alarm has been silenced and cleared from the display, you may still review the points that were in alarm.

1. Make sure the system is turned off (All and Part indicators are off).
2. Press [CMD] [4] [0]. Enter passcode if prompted. The Command Center displays all points that are in alarm memory.
3. To clear the alarm memory, turn the system on and then off.
 - If the point indicator is flashing fast, the alarm is currently in alarm or was in alarm.
 - If the point indicator is flashing slow, the alarm was aborted. No reports for the alarm event were sent to the security company.



The LED Command Center only displays Points 1 to 16.

View System Trouble (Cmd 42)

Use this command to view system trouble events. A system trouble condition may occur if there is a communications trouble, or it is time for the system to be serviced by your security company.

1. Make sure the system is turned off (All and Part indicators are off).
2. Press [CMD] [4] [2]. The Command Center may prompt you to enter a valid passcode by flashing the Cmd light.
3. Enter your passcode. The Command Center displays current system trouble events by lighting the point indicators. See *Table 6*.

Point #	Description	
1	On	Telephone Line Fail
	Flashing Slow	Comm Fail, Destination 1
	Flashing Fast	Comm Fail, Destination 2
2	On	Alternate Comm Trouble
3	On	Installer Switch Closed
4	On	Backup Battery Low
	Flashing Slow	Backup Battery Missing
5	On	Bell Supervision Fail
6	On	RF Receiver Jammed
	Flashing Slow	RF Receiver Trouble
7	On	Data Bus Device Missing
	Flashing Slow	Data Bus Tamper
	Flashing Fast	Data Bus Device Trouble/Reset
8	On	System Fault
	Flashing Slow	Service Interval
	Flashing Fast	Ground Fault Condition

Table 6: System Trouble Events

4. Press [CMD] twice to exit the View System Trouble command.

D621 User's Guide

View Point Trouble (Cmd 48)

- I can perform this command.
- I cannot perform this command.

Use this command to view which points (if any) are in trouble.

1. Make sure the system is turned off (All and Part indicators are off).
2. Press [CMD] [4] [8]. The Command Center may prompt you to enter a valid passcode by flashing the Cmd light.
3. Enter your passcode. The Command Center displays all points that are in trouble (if any). See *Table 7*.



The LED Command Center only displays Points 1 to 16.

Point	Trouble Condition
Off	No Point Trouble
On	Wiring Fault
Flashing Slow	RF Sensor Low Battery
Flashing Fast	RF Sensor Missing

Table 7: Trouble Points

4. Press [CMD] twice to exit the View Point Trouble command.

System Test (Cmd 41)

- I can perform this command.
- I cannot perform this command.

The System Test command allows you to ensure your system is operating correctly by testing the system's bell, strobe, battery, and phone line. Only those programmed by your installing security company are tested (your system may only be programmed to test the back-up battery and the bell output).

I can test:

- System Bell Battery
- System Strobe Phone Line

If any of these components fails to test, contact your security company for assistance. Be sure to contact your security company before you begin the system test.

1. Make sure the system is turned off (All and Part indicators are off).
2. Press [CMD] [4] [1]. The Command Center may prompt you to enter a valid passcode by flashing the Cmd indicator.
3. Enter your passcode if necessary. The system starts the test. As each test is underway, the corresponding point indicator lights. See *Table 8*.

Point #	Testing
1	Bell
2	Strobe (may take up to 20 min.)*
3	Backup Battery (may take 4 min.)*
4	Communications (may take up to 10 min.)*

* To skip to the next text, press the [*] key.

Table 8: System Test Lights



When testing the bell and strobe, check for bell/strobe activation. The LED testing status does not indicate bell/strobe test failure (point indicator does not flash fast upon test failure).

D621 User's Guide

As the system tests each bell, strobe, battery, and system's communication, the corresponding point indicator displays the stage of each test. See *Table 9*.

Point	Testing Status
Flash Slow	Testing Segment Underway
Flash Fast	Testing Segment Failed
On	Testing Segment Complete

Table 9: System Test Point Status

4. When the test is complete, the Command Center automatically exits this command.
5. To stop the test currently in progress and skip to the next test, press the [*] key. To abort all system tests and return to the normal display, press the [CMD] key.

Walk Test (Cmd 44)

- I can perform this command.
- I cannot perform this command.

Use this command to walk-test detection devices connected to your system. Perform the Walk Test on a weekly basis. The types of devices that can be walk-tested are configured by your security company.

1. Make sure the system is turned off (All and Part indicators are off).
2. Press [CMD] [4] [4]. The Command Center may prompt you to enter a valid passcode by flashing the Cmd indicator.
3. Enter your passcode if necessary. The Command Center emits a single tone.
4. To test each point, trigger the corresponding detection device (such as open a door or walk in front of a motion detector) until all points are tested. When a point is tested, the Command Center emits a single 1 sec. tone and the corresponding point indicator turns on. When the tested point is restored, the Command Center emits a second single 1 sec. tone and the corresponding point indicator turns off.
5. To exit the walk test, press [CMD]. The Status indicator flashes rapidly. Walk Test is over when the Status indicator stops flashing.



Test fire detection devices (smoke/heat detectors) weekly as instructed by your security company and in accordance with the devices instructions.

Reset the System (Cmd 47)

- I can perform this command.
- I cannot perform this command.

Use this command to reset the system (including fire points) after an alarm. Detection devices, such as smoke detectors and shock sensors, must be reset after being activated. Resetting the system takes about 20 seconds.

If points do not reset, contact your alarm company for help.

1. Ensure your system is off (All and Part indicators are off).
2. Press [CMD] [4] [7]. The Command Center may prompt you to enter a valid passcode by flashing the Cmd indicator.
3. Enter your passcode if necessary. The system now resets. After the system resets, the Command Center automatically exits this command.

D621 User's Guide

Turn Watch On/Off (Cmd 61)

- I can perform this command.
- I cannot perform this command.

Use the Watch feature to “watch” points when the system is off. For example, parents with small children may want a tone to sound whenever a door or window is opened as a way of monitoring the location of the children.

Use this command to turn the watch feature on and off.

Once you have programmed the system with points to watch (see *Select Watch Points*) and the responses (see *Select Watch Tone*), you need to turn the watch function on and off.

1. Make sure your system is off (All and Part are off).
2. Press [CMD] [6] [1]. The Command Center may prompt you to enter a valid passcode by flashing the Cmd indicator.
3. Enter your passcode, if necessary. The Command Center beeps for 1 sec. to indicate that Watch is now on or off, depending on the applied setting.
 - If Watch Tone is ON, the LED indicator for Point 2 flashes. Press [2] to turn off.
 - If Watch Tone is OFF, the LED indicator for Point 1 flashes. Press [1] to turn on).

Select Watch Tone (Cmd 62)

- I can perform this command.
- I cannot perform this command.

The Watch feature gives you the ability to “watch” points when the system is off. For example, parents with small children may want a tone to sound whenever a door or window is opened as a way of monitoring the whereabouts of the children.

Use this command to set the type of response your system produces when a watch point is faulted. If you wish, you may tell your system to display the point's LED indicator and sound a short tone whenever certain doors or windows are opened. See *Select Watch Points* for information on programming which points in your system are to be “watched”.

1. Make sure your system is off (All and Part indicators are off).
2. Press [CMD] [6] [2]. The Command Center may prompt you to enter a valid passcode by flashing the Cmd indicator.
3. Enter your passcode if necessary. The Command Center displays steady the current choice and flashes the other possible choices. The factory default watch tone setting is Short Beep (Choice 2).
4. Select the type of watch tone you want by pressing the required digit. See *Table 10*.

Choice #	Tone
1	No Tone
2	Short Beep
3	Beep Until Key
4	Beep Until Closed

Table 10: Watch Tones

5. If you just want to review (not change) the current watch tone setting, press [CMD] to exit this function.

D621 User's Guide

Table 11 gives a description of each watch tone.

Watch Tone	Description
Off	Displays point(s), but no tone when point(s) is faulted.
Short Beep	Displays point and sounds a short tone when point(s) is faulted.
Beep Till Key	Displays point and sounds a tone until the [CMD] key is pressed.
Beep Till Closed	Displays point and sounds a tone until the point(s) is returned to normal (door or window is closed). Pressing the [CMD] key also silences the tone.

Table 11: Watch Tone Description

6. After making your selection, the display confirms the choice you made by displaying the corresponding point on the Command Center before exiting this command. The selected point indicator turns on solid.

Select Watch Points (Cmd 63)

- I can perform this command.
- I cannot perform this command.

The Watch feature gives you the ability to “watch” points when the system is off. For example, parents with small children may want a tone to sound whenever a door or window is opened as a way of monitoring the location of the children.

Once you have decided how your system responds to watched points (see *Select Watch Tone*), you need to decide which of the points in your system will be watched. Use this command to tell your system which points to watch. You cannot watch 24-hr. or fire points.

Choosing which points to watch depends upon your goals. If you have small children, you may choose to watch points of entry and exit. Each time a watch point is faulted (a door or window is opened), the Command Center responds as programmed. For example, you may tell your system to produce a short beep when a watch point is faulted.

1. Make sure your system is off (All and Part indicators are off).
2. Press [CMD] [6] [3]. The Command Center may prompt you to enter a valid passcode by flashing the Cmd indicator.
3. Enter your passcode if necessary. The Command Center displays all points that are currently being watched (Watch On).
 - **Point Indicator On Solid:** indicates point(s) already being “watched.”
 - **Point Indicator Flashing:** indicates point(s) available to be “watched.”
4. Enter the point number you want to watch followed by the [*] key. (For example, press [5] [*] to watch Point 5.) Repeat this step to select all the points you want to watch. To turn Watch Mode off for a point, enter the point number followed by the [*] key. (For example, press [5] [*] to turn Watch off for Point 5.)

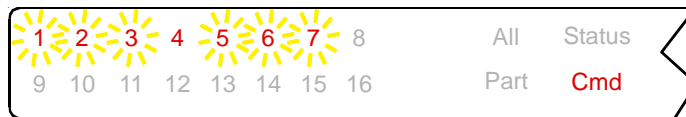

5. Press [CMD] to exit this command.

D621 User's Guide

Extend Auto On Time (Cmd 51)

- I can perform this command.
- I cannot perform this command.

Your security company can program your system to turn on automatically. This command allows you to delay the auto-on time by one hour during the auto-on pre-alert time.

1. Make sure the system is turned off (All and Part indicators are off).
2. Press [CMD] [5] [1]. The Command Center may prompt you to enter a valid passcode by flashing the Cmd indicator.
3. Enter your passcode if necessary. The Command Center sounds a valid tone.

All Areas On (Cmd 80)

- I can perform this command.
- I cannot perform this command.

Depending on the areas assigned to your authority level, this command allows you to turn on all areas at the same time when the system is split into more than one area.

1. Press [CMD] [8] [0]. The Command Center may prompt you to enter a valid passcode by flashing the Cmd indicator.
2. Enter your passcode. If your passcode is valid, the Command Center illuminates the All On indicator and exit delay starts.

If an area has a faulted point(s) when you try to turn all areas All On, the appropriate Point LED illuminates (Points 1 to 16). Hold down the All On key for 2 sec. to force all areas to All On.

The Command Center lights Point Indicators 1 to 4 to indicate the areas that are forced on. These indicators are:

- Point 1 Indicator = Area 1
- Point 2 Indicator = Area 2
- Point 3 Indicator = Area 3
- Point 4 Indicator = Area 4

All Areas Off (Cmd 81)

- I can perform this command.
- I cannot perform this command.

Depending on the areas assigned to your authority level, this command allows you to turn off all areas at the same time when the system is split into more than one area.

1. Press [CMD] [8] [1]. The Command Center may prompt you to enter a valid passcode by flashing the Cmd indicator.
2. Enter your passcode if necessary. The Command Center turns off all areas at the same time.

Auto-Forward On/Off (Cmd 82)

- I can perform this command.
- I cannot perform this command.

This command allows you to turn on or off the auto-forward feature as necessary.

1. Press [CMD] [8] [2]. The Command Center may prompt you to enter a valid passcode by flashing the Cmd indicator.
2. Enter your passcode if necessary. The Command Center sounds the valid entry tone.
3. Press [1] to turn auto-forward on or press [2] to turn auto-forward off.
 - **Point Indicator 1 On Solid:** Auto-Forward ON (Point Indicator 2 flashes)
 - **Point Indicator 2 On Solid:** Auto-Forward OFF (Point Indicator 1 flashes)
4. Press [CMD] to exit this command.

D621 User's Guide

Remote Arming with Telephone, Area 1

- I can perform this command.
- I cannot perform this command.

This function controls the built-in telephone arming feature for Area 1. When enabled, the panel answers the phone on the programmed ring count.

When the panel answers the phone, it

- sounds three beeps and starts the handshake tone for remote programming if the panel is All or Part On.
- sounds one short beep, waits approximately 3 sec., and then sounds one long beep if the panel is Off. Press and hold the [5] key* for 2 sec. immediately **after** the first short arming beep and **before** the long beep begins.
- arms if it detects a [5] key press from the telephone (All On with Delay, faulted points are force-armed). The panel sounds three beeps (new armed state) and then hangs up.

* If arming from a cell phone, quickly press the [5] key three times. If pressing and holding the [5] key for 2 sec. from a house (land-line) phone does not produce a tone long enough to arm Area 1, retry by quickly pressing the [5] key three times.



Remotely disarming the panel cannot be done with a telephone.

Remote Program (Cmd 43)

- I can perform this command.
- I cannot perform this command.

This command forces the system to connect to your security company's remote PC computer for programming alterations via the telephone line. **Only use this feature under the direction of your security company.**

1. Ensure the system is turned off (All and Part indicators are off).
2. Press [CMD] [4] [3]. The Command Center may prompt you to enter a valid passcode by flashing the Cmd indicator.
3. Enter your passcode. The Command Center emits a single-beep tone, indicating the remote programming session has begun. When the session is completed, the Command Center automatically exits this command.

Security System Limitations

Not even the most advanced security system can guarantee protection against burglary, fire, or environmental threats. All security systems are subject to possible compromise or failure-to-warn for a variety of reasons including, but not limited to, the following:

- If sirens or horns are placed outside the hearing range of people in remote areas of the building or in areas which are frequently closed off, they do not provide the intended protection.
- If intruders gain access through unprotected points of entry, the system does not detect their entrance.
- If intruders have the technical means of bypassing, jamming, or disconnecting all or part of the system, they are not detected.
- If the AC power supply is OFF and the back up battery is either missing or dead, sensors do not detect intrusion.
- Smoke detectors cannot detect smoke in chimneys, walls, or roofs, or smoke blocked by a closed door. They may not detect smoke or fire on a level of the building different from the one on which they are located. Smoke detectors may not be able to warn in time about fires started by explosions, improper storage of flammables, overloaded electrical circuits, or other types of hazardous conditions.
- If phone lines are out of service, reports from the security system to the security company cannot be sent. Telephone lines are vulnerable to compromise by several means. Inadequate maintenance and failure to test are the most common causes of alarm failure. It is strongly recommended that you test your system once a week to be sure that all system components are working properly. Although having a security system may make you eligible for reduced insurance premiums, the system is no substitute for insurance. Warning devices cannot compensate you for loss of life or property.

D621 User's Guide

Fire Safety and Evacuation

Residential fire is a leading cause of accidental death. Most fire related deaths occur at night when occupants suffocate in their sleep from smoke and toxic gases, rather than from burns. To help reduce this risk, the following program should be implemented.

1. Minimize fire hazards. Smoking in bed, cleaning with flammable liquids such as gasoline, leaving children home alone, and using unsafe holiday decorations are some of the common causes of household fire.
2. Install a fire alarm system. The primary purpose of this system is to protect lives by giving the earliest possible warning of danger.
3. A smoke detector should be provided to protect each sleeping area in a home.
4. Practice an escape plan. Because there may be very little time between detection of a fire and the time it becomes deadly, it is important that every member of the family understand how to quickly evacuate according to the plan.
5. Plan both primary and alternate escape routes. Since stairwells and hallways may be blocked during a fire, exiting through a bedroom window must be a part of the escape plan. If the sleeping area is above the ground floor, install a means of safely descending outside the building if one does not already exist.
6. As a part of this plan, all family members should arrange to meet at a location away from the house (such as a neighbor's house) so you will know that everyone is accounted for.
7. If it is determined that the alarm was accidentally sounded, the bell should be silenced, the detectors reset, and your security company notified immediately that there is no emergency situation.

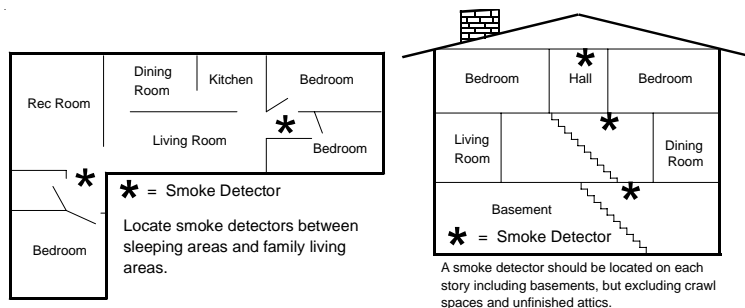

Maintenance and Service

This security system requires very little maintenance; however, you should test the system weekly to ensure it is working properly. A test schedule and maintenance program can be arranged. If you notice a change in operation during normal use or testing, call for service as soon as possible. Do not attempt to repair the control panel, Command Centers, or detectors yourself.

See the information box for security company, contact, and installation information.

Power Failure

If the Command Center indicates a power failure, and you have power in the rest of your premises, there may be a problem with the electrical transformer or circuit breaker supplying power to your security control panel. First, check to be sure that the transformer is securely plugged into the electrical outlet. If it appears to be damaged in any way, do not attempt to repair it. Call your security company for service.

See the information box for transformer information.

If the transformer is plugged in, check the circuit breaker supplying power to the outlet. If the breaker is tripped, check the appliances on the circuit for signs of electrical problems. Make sure someone has not intentionally turned the breaker off. When all is clear, reset the breaker.

See the information box for the circuit breaker number.

How to Clean the Command Center

If your Command Center gets dirty, apply a household glass cleaner to a clean cloth or paper towel and wipe the surface. Do not spray any liquid directly onto the Command Center. It could run inside the case and damage electrical circuits.

D621 User's Guide

Glossary

24-Hour Points	Points that are always on even when the system is turned off. There are two types of 24-Hour Points: Fire Points and Non-Fire Points.
All On	Turn on all of the points in the system.
Burglary Alarm Tone	Constant warble tone.
Bypass	Selectively remove points from the security system, temporarily.
Central Station	Facility where trained personnel monitor your security system 24-hr. a day. Your security system may be programmed to contact the central station during alarm conditions, enabling central station personnel to dispatch the proper authorities.
Controlled Point	Point that reports alarm conditions only when the system is turned on.
Entry Delay	Programmed delay of the system alarm response that allows you to enter the building through the entry door to turn your system off. An alarm response begins if you do not turn the system off before the entry delay expires. Entry delay is programmed by your security company.
Error Tone	Same warble tone as Trouble Tone, but not repeated.
Exit Delay	Programmed delay of the system alarm response that allows you to exit after turning the system on. If you don't exit the building before the delay time expires, an alarm response begins. Exit delay is programmed by your security company.
Faulted Point	Point that is not normal, such as an open door or window.
Fire Alarm Tone	Warble tone that is on for 1 sec. and then briefly off (repeatedly).

D621 User's Guide

Fire Point	Type of 24-Hour Point that only monitors a fire detection device(s), such as a smoke detector. This type of point is always on and cannot be turned off.
Hold	Instruction to press and hold a key to perform a function.
No Delay	Turns the system on without entry or exit delay.
Non-Fire Point	Type of 24-Hour Point that is always on and cannot be turned off.
Off Display	Display that appears when the system is turned off and no keys are pressed.
Part On	Turn on part of the points in the system. Part On points are determined by your security company.
Part 2 On	Turn on part of the points in the system. Part 2 On points are determined by you, the user.
Point	Detection device or group of devices connected to your security system.
Press/Push	Interchangeable terms instructing you to push down and then release a key.
Trouble	Service condition that needs to be corrected, such as a broken wire.
Trouble Tone	Warble tone that is on briefly, followed by a pause, and then followed by the warble tone (repeatedly).
Warble Tone	Tone that is on for 1 sec., then briefly off.

Index

A	K	R
Alarm Memory 30	Keys 8	Remote Arming 42
Alarms 12	L	Reset the System 35
Burglary 11	Logging Out of the	S
Fire 11	System 13	Silencing Alarms 12
Silencing 12	M	System Events 10
All On 7, 14	Maintenance 45	System Limitations 43
Area 40, 41	N	System Test 33
Off 41	Non-Fire 24-Hour	System Trouble 29, 31
On 40	Points 6	T
Auto On Time 40	Non-Fire Trouble	Testing
Auto-Forward 41	Events 11	System 33
On/Off 41	O	Walk 34
B	On with No Delay . 18	Time 22
Burglary Alarms 11	On with Points	Tones 9
Bypass Points 21	Faulted 20	Turn the System
C	One-Time	Off 13
Change Others'	Passcodes 28	Turning the System
Passcodes 24	P	On with No
Cleaning 45	Part 2 On 16	Delay 18
Commands 10	Part 2 Points 17	On with No Exit
D	Part On 7, 15	Tone 19
Date 22	Passcode 23	W
Delay Silent 19	Change Level 25	Walk Test 34
Delete Passcodes 27	Change Other 24	Watch 36
E	Delete 27	On/Off 36
Evacuation 44	One-Time 28	Watch Points 39
F	Passcode Level 25	Watch Tone 37
Faulted Point 6	Point 6	
Fire Alarms 11	Faulted 6	
Fire Points 6	Non-fire 24-hour 6	
Fire Trouble Events 11	Point Trouble 32	
	Power Failure 45	